



FURNITURE CARE GUIDE
AZUR CONFORT



TABLE OF CONTENTS

General **p. 3**

Use and storage

Folding the director's chair

Wood care **p. 5**

Lacquer finish

Woodstain finish

Oil finish

Fabric care **p. 9**

Removable canvas

Serge Ferrari fabric

Sunbrella fabric

If you have any questions, our team is at your disposal.
Send us an email at : contact@azur-confort.com



GENERAL

EVERYDAY USE

- We recommend the use of coasters and placemats to reduce the risk of scratches.
- After each service, clean the surface with cold water. Wipe dry with a soft cloth.
- If your customers are likely to have sun cream on their skin, we recommend to clean the armrest regularly : these creams contain agents that are aggressive to your furniture finishes.
- When handling furniture, particularly tables, it is preferable to carry them rather than pull them across the floor.
- When handling and/or storing furniture, avoid bumping.

STORAGE

- If not used, store your furniture away from the rain, keeping horizontal surfaces to a minimum. This will prevent problems caused by water not draining away :
 - The director's chairs (F104, Heritage and F204) must be stored folded upright, at a slight angle.
 - Tables should be slightly tilted.

⚠ Do not use protective tarpaulins if the furniture is stored in the sun. You run the risk of drying out and damaging your furniture.



FOLDING THE DIRECTOR'S CHAIR

To avoid wrinkles and signs of wear on your director's chairs, we recommend that you fold them as follows :

1. GRAB THE SEAT COVER

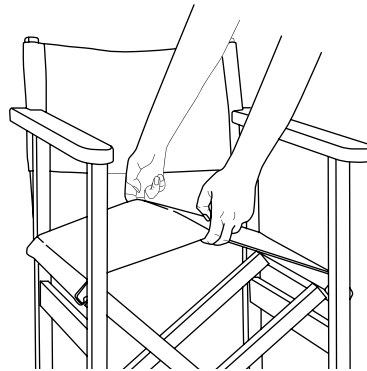

Grab the seat cover of the chair by placing your hands in the centre of the cover. One at the front and the other at the back of the seat.

2. PULL THE FABRIC UPWARDS

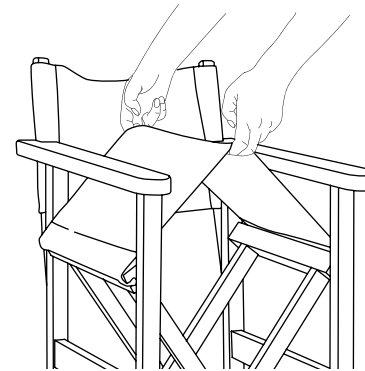

Roll up the cover using your hands. The chair folds up by itself, with no risk of pinching yourself or damaging the cover.

3. PLACE THE COVER ON THE ARMREST

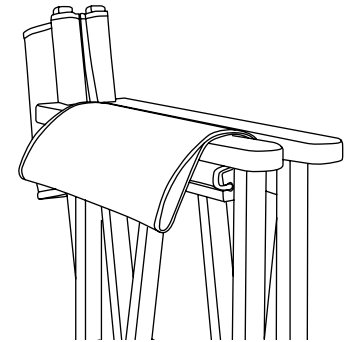

Let the seat cover fall back onto the armrest. Make sure the backrest cover does not wrinkle.

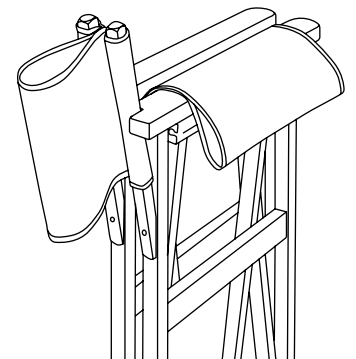



WOOD CARE



LACQUER FINISH

ABOUT

Azur Confort offers you a unique range of colours for your lacquered wood furniture. Because of the film created on the wood and the contrast of colours, these lacquered finishes are sensitive to wear, scratches and impacts.

Our lacquers are developed to allow you to use your terrace for several seasons, while ensuring regular maintenance.

Depending on use (location, intensity of use, exposure to sun, water, frost, sea salt, ...) the ageing of the furniture can be accelerated.

MAINTENANCE

After each service, clean the surface with cold water. Wipe dry with a soft cloth.

REFURBISH

You want to refurbish your furniture. With a focus on sustainability and the eco-design of our furniture, we offer a service to restore your furniture to its condition.

Please contact us for a quote :
by email [**contact@azur-confort.com**](mailto:contact@azur-confort.com)

WOODSTAIN FINISH

ABOUT

Our woodstains are developed to allow you to use your terrace for several seasons, while ensuring regular maintenance.

Depending on use (location, intensity of use, exposure to sun, water, frost, sea salt, ...) the ageing of the furniture can be accelerated.

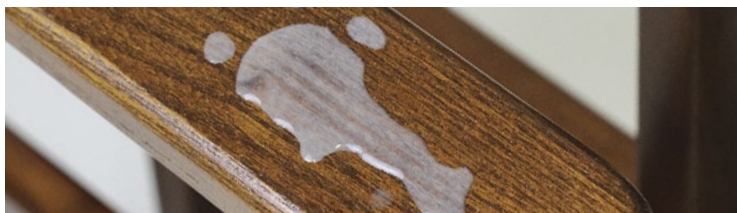

⚠ During the first few weeks of use, greening or bleaching of the furniture may occur.

This is due to :

- Prolonged storage in the shade following receipt of the furniture : the stains will disappear after a few weeks once the furniture has been placed outdoor.
- Or the woodstain may have picked up moisture during the catalysis cycle. In this case, place the furniture in a dry space. The marks will disappear after a month.

MAINTENANCE

After each service, clean the surface with cold water. Wipe dry with a soft cloth.

REFURBISH

You want to refurbish your furniture. With a focus on sustainability and the eco-design of our furniture, we offer a service to restore your furniture to its condition.

Please contact us for a quote :
by email contact@azur-confort.com

OIL FINISH

ABOUT

Our oils are developed to allow you to use your terrace for many seasons, while retaining a very natural look : this finish tints the wood while allowing its grain and texture to show through.

Oiled furniture is easier to maintain, but needs to be done more regularly : at least every year, up to once per season depending on its use.

 As the oil finish is sensitive to UV rays, your furniture will tend to darken over time.

Depending on use (location, intensity of use, exposure to sun, water, frost, sea salt, ...) the ageing of the furniture can be accelerated.

EVERYDAY MAINTENANCE

After each service, clean the surface with cold water. Wipe dry with a soft cloth.

ANNUAL MAINTENANCE

As there are many shades of oil available, we advise you to contact us if you are in any doubt about which product to use.

Recommendations

- When maintaining your furniture, keep it in a well-ventilated place, away from the rain, between 5°C and 30°C (40°F - 86°F)
- Clean your furniture with cold water and let it dry for a full day before applying the maintenance coat.

Apply the maintenance coat

- Stir the product and shake the bottom of the jar to obtain an even shade.
- Apply your oil all over your furniture, following the direction of the grain. Use a brush or a roller with active microfibre.
- Massage the wood, going over the same areas multiple times to help the oil absorb into the wood.
- Leave to dry for at least a day before using the furniture.



FABRIC MAINTENANCE



CANVAS CLEANING

TYPE OF FABRIC

We work mainly with Serge Ferrari and Sunbrella fabrics. You will find the brand of your fabric on the back of the AZUR CONFORT label sewn onto your canvas.

However, it is possible that the canvas of your furniture is of another fabric. In this case, please contact us so that we can guide you to the right fabric manufacturer.

REMOVING CANVASES

Canvas does not have to be removed for cleaning.

however, it may be useful to remove the covers from your furniture if it is to be refurbished or machine-cleaned (depending on the fabric, please refer to the recommendations).

⚠ Not all covers can be removed. To find out whether you can remove the canvases from your furniture, consult the table on the next page.

MATTRESSES AND CUSHIONS

All our mattresses and cushions have removable covers. The cleaning of the covers will depend on the type of fabric. If you are unsure about your cover, please contact us by email : contact@azur-confort.com

LIST OF REMOVABLE CANVASES

SÉOL

FURNITURE

REMOVABLE

NON-REMOVABLE



DIRECTOR'S CHAIR
F104
HERITAGE
F204

backrest
seat



LOUNGE CHAIR
SÉOL

backrest seat



LOUNGE SOFA
SÉOL

backrest
(snap buttons) seat



SUN LOUNGER
SÉOL

seat

FURNITURE

REMOVABLE

NON-REMOVABLE



DECKCHAIR SÉOL

seat



FOLDING STOOL
SÉOL

seat
⚠ *canvas held in place by staples*

ESTIU



DIRECTOR'S CHAIR
F104S

backrest
seat

REMOVING CANVAS

EQUIPMENT



- Screwer
- Torx T30 bit
- Wooden rod

You can replace the wooden rod with a biro or a screwdriver.

1. UNSCREW THE BACKREST



Using a screwdriver and a Torx T30 bit, remove the screw holding the armrest and the backrest support together.

2. INCLINE THE UPRIGHTS



Tilt the uprights inwards so that you can remove the fabric without damaging it.

If necessary, you can loosen the crosshead screw at the bottom of the upright.

3. REMOVE THE BACKREST COVER



Slide the backrest cover upwards to remove it from the chair.

To refit the covers, use the holes already present on the covers.

4. FOLD THE CHAIR



Fold the chair so you can easily access the groove in which the fabric is held.

5. REMOVE THE PLASTIC TUBE



Using the wooden rod, push the plastic tube out of the other end of the chair.

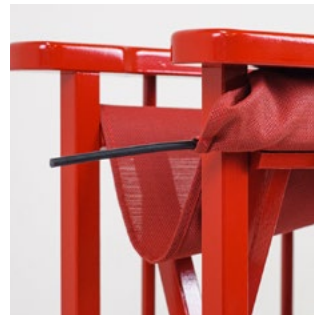

Pull on the plastic tube to remove it completely.

6. REMOVE THE SEAT

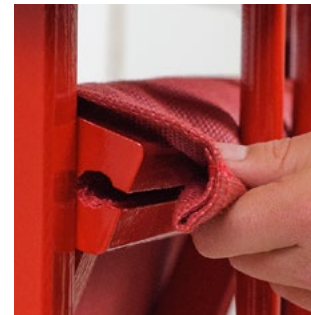

Remove the seat cover from its groove. The cover should be easy to remove : don't pull or you'll damage the fabric.



Repeat steps 5 and 6 on the other side of the chair to remove the seat completely.

SERGE FERRARI FABRICS

ABOUT

Our outdoor furniture uses the BATYLINE EDEN range from Serge Ferrari, the perfect combination of technical performance and the softness of a textile look.

BATYLINE EDEN fabrics can be recognised by their PVC threads woven into a grid.

MAINTENANCE

Serge Ferrari fabrics can be washed with cold soapy water :

- Use a mild soap, such as black soap.
- Make circular movements with a soft brush, then remove the deposits with a damp sponge.
- Rinse with clean water.
- Dry the surfaces with a soft cloth.

If stain persists, you can repeat the process with a mix of bicarbonate and white vinegar.

Serge Ferrari fabrics do not require any treatment after washing.

You can also use Serge Ferrari Cleaner 500 to clean your canvases. Follow the instructions of use provided by the brand.

Serge Ferrari fabrics must **not** :

- be dry cleaned
- be washed in a washing machine
- come into contact with heating elements : no iron nor hot steam.

SUNBRELLA FABRICS

ABOUT

Our outdoor furniture uses Sunbrella's CANVAS range, fabrics that combine design and performance to create comfortable, hard-wearing furniture.

Sunbrella fabrics have an appearance similar to natural fabrics.

HAND CLEANING

Sunbrella fabrics can be washed with cold soapy water :

- Use a mild soap, such as black soap.
- With a soft brush, clean the entire surface, from seam to seam, to avoid water spots
- Remove deposits with a damp sponge.
- Rinse with clear water.
- Dry with a soft cloth.

If a stain persists or if you notice traces of mould, you can repeat the wash by adding 6 cl of bleach per litre of soapy water.

MACHINE CLEANING

Sunbrella fabric canvas and cushion or mattress covers can be machine washed.

For machine cleaning, use :

- A gentle cycle
- Cold water : 30°C maximum
- Spin 800 rpm maximum
- Air dry  never tumble dry



It is possible that the properties of the fabric will diminish with each wash. To reactivate the fabric's resistant properties, we recommend using Tex' Aktiv Guard by Sunbrella.

Follow the manufacturer's instructions.



FURNITURE CARE GUIDE
AZUR CONFORT